

# Service Service Service



# Service Manual

## TABLE OF CONTENTS

	Chapter
Technical Specification, PCBs Location.....	1
Safety Instruction .....	2
Instruction for Use.....	3
Mechanical and Dismantling Instructions.....	4
Service Modes, Troubleshooting.....	5
Overall Block Diagram, Wiring Diagram.....	6
Electrical Diagram.....	7
Exploded View Diagram & Service Part List.....	8
Revision List.....	9

©Copyright 2009 Philips Consumer Electronics B.V. Eindhoven, The Netherlands  
 All rights reserved. No part of this publication may be reproduced, stored in a retrieval system or transmitted, in any form or by any means, electronic, mechanical, photocopying, or otherwise without the prior permission of Philips.

## 1.0 TECHNICAL SPECIFICATION

---

### VIDEO/ AUDIO Characteristic Testing discs

---

Test discs: DOLBY: Dolby Test disc  
ABEX: TDV-540A

### VIDEO FORMAT

---

DVD / SVCD / JPEG / MPEG4 / DIVX3, 4,5,6(Home theater)

### AUDIO FORMAT

---

CD / MP3(32 - 320 kbps)

### Video (PAL / NTSC)

---

White bar : 714mV +10%/-20%  
Sync. Amplitude: 286mV  $\pm$ 40mV  
Burst/chroma ratio:  $\pm$  15%  
S/N luminance: >42 dB

### POWER CONSUMPTION

---

Power-Supply(AC-DC Adaptor):  
Supply voltage: AC 100~240V  $\pm$ 10%  
Supply Power consumption(AC adaptor 100/240V): 9V 0.8A  
A +10%  
DC Power supply(Operate voltage range): 6.2V-15.49V $\pm$ 10%  
Standby Power (AC adaptor, no load),264VAC: <0.75W

### GENERAL DESCRIPTION

---

Optical Pickup: ASA PM2381-D(850PH)  
Chip set/ Solution: SPHE8202PS-A  
Disc Size:8cm/12cm

1.1 PCBs Location

---

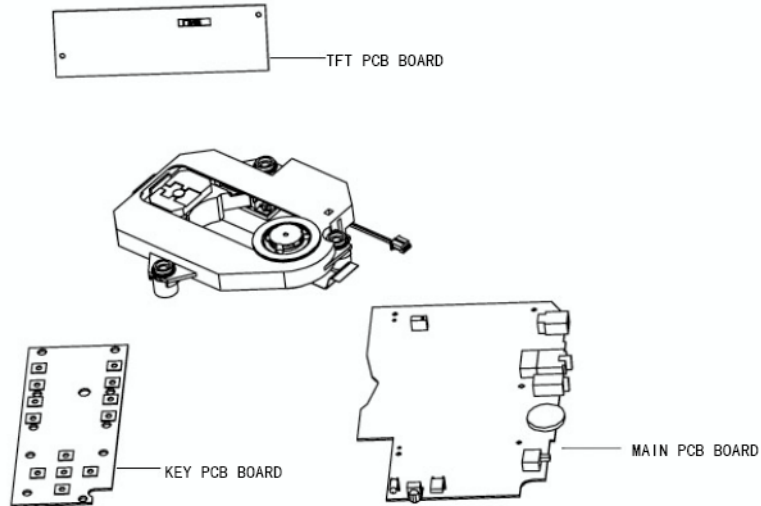

VERSION VARIATIONS

Type/Versions: Service policy	PD7010						
	12	93	77				
Board in used:							
MAIN BOARD	M	M	M				
KEY BOARD	M	M	M				
TFT BOARD	M	M	M				

\*TIPS: C -- Component Lever Repair.  
M -- Module Lever Repair  
X -- OCX

## 1.2 System, Region Code, etc. Setting Procedure

---

### Procedure to change region code of your DVD Portable

1. Power ON the DVD player and do not insert DISC inside player
2. Setup→ Prefer  
Press ►(FF)→ ◀(FW)→ ►(FF) → ◀(FW) → ►(FF)→ ►(FF)→ ◀(FW)  
The LCD display showed the existing region Code
3. Press ▲(navigation up)or ▼(navigation down) repeatedly to select the number from 1 to 6.
4. Then press OK to confirm your region code.
5. Refer below table for your region code setting

Region Code	Region
1	USA
2	EUROPE
3	ASIA PACIFIC
4	AUSTRALIA, NEW ZEALAND, LATAM
5	RUSSIA, INDIA
6	CHINA

### Procedure for SW upgrade

1. The upgrade will provide a document re-named: PHILIPS.BIN
2. "PHILIPS.BIN" copy to CD-ROM into the data;
3. Reading the CD-ROM, in accordance with prompt, press "OK" key to upgrade

**Warning: Do not unplug the AC adapter during firmware upgrade to prevent flash corrupt of the set!!**

### Procedure to check SW version of your DVD Portable

1. OPEN
2. Press SETUP MENU
3. Select Preferences
4. Select Version Info
5. Press "OK" key

## 2.0 SAFETY INSTRUCTIONS

**(GB) WARNING**

All ICs and many other semi-conductors are susceptible to electrostatic discharges (ESD). Careless handling during repair can reduce life drastically.  
When repairing, make sure that you are connected with the same potential as the mass of the set via a wrist wrap with resistance. Keep components and tools also at this potential.

**(F) ATTENTION**

Tous les IC et beaucoup d'autres semi-conducteurs sont sensibles aux décharges statiques (ESD). Leur longévité pourrait être considérablement écourtée par le fait qu'aucune précaution n'est prise à leur manipulation.  
Lors de réparations, s'assurer de bien être relié au même potentiel que la masse de l'appareil et enfiler le bracelet serti d'une résistance de sécurité.  
Veiller à ce que les composants ainsi que les outils que l'on utilise soient également à ce potentiel.

**(D) WARNUNG**

Alle ICs und viele andere Halbleiter sind empfindlich gegenüber elektrostatischen Entladungen (ESD).  
Unvorsichtige Behandlung im Reparaturfall kann die Lebensdauer drastisch reduzieren.  
Veranlassen Sie, dass Sie im Reparaturfall über ein Pulsarmband mit Widerstand verbunden sind mit dem gleichen Potential wie die Masse des Gerätes.  
Bauteile und Hilfsmittel auch auf dieses gleiche Potential halten.

**(NL) WAARSCHUWING**

Alle IC's en vele andere halfgeleiders zijn gevoelig voor electrostatische ontladingen (ESD).  
Onzorgvuldig behandelen tijdens reparatie kan de levensduur drastisch doen verminderen.  
Zorg ervoor dat u tijdens reparatie via een polsband met weerstand verbonden bent met hetzelfde potentiaal als de massa van het apparaat.  
Houd componenten en hulpmiddelen ook op hetzelfde potentiaal.

**(I) AVVERTIMENTO**

Tutti IC e parecchi semi-conduttori sono sensibili alle scariche statiche (ESD).  
La loro longevità potrebbe essere fortemente ridotta in caso di non osservazione della più grande cauzione alla loro manipolazione.  
Durante le riparazioni occorre quindi essere collegato allo stesso potenziale che quello della massa dell'apparecchio tramite un braccialetto a resistenza.  
Assicurarsi che i componenti e anche gli utensili con quali si lavora siano anche a questo potenziale.

**(GB)**

Safety regulations require that the set be restored to its original condition and that parts which are identical with those specified, be used.

"Pour votre sécurité, ces documents doivent être utilisés par des spécialistes agréés, seuls habilités à réparer votre appareil en panne".

**(NL)**

Veiligheidsbepalingen vereisen, dat het apparaat bij reparatie in zijn oorspronkelijke toestand wordt teruggebracht en dat onderdelen, identiek aan de gespecificeerde, worden toegepast.

**(F)**

Les normes de sécurité exigent que l'appareil soit remis à l'état d'origine et que soient utilisés les pièces de rechange identiques à celles spécifiées.

**(D)**

Bei jeder Reparatur sind die geltenden Sicherheitsvorschriften zu beachten. Der Originalzustand des Geräts darf nicht verändert werden; für Reparaturen sind Original-Ersatzteile zu verwenden.

**(I)**

Le norme di sicurezza esigono che l'apparecchio venga rimesso nelle condizioni originali e che siano utilizzati i pezzi di ricambio identici a quelli specificati.

"After servicing and before returning set to customer perform a leakage current measurement test from all exposed metal parts to earth ground to assure no shock hazard exist. The leakage current must not exceed 0.5mA."

**(GB) Warning !**

Invisible laser radiation when open.  
Avoid direct exposure to beam.

**(S) Varning !**

Osynlig laserstrålning när apparaten är öppnad och spårren är urkopplad. Betrakta ej strålen.

**(SF) Varoitus !**

Avatussa laitteessa ja suojalukituksen ohitettaessa olet alltiina näkymättömälle laserisäteilylle. Älä katso säteeseen!

**(DK) Advarsel !**

Usynlig laserstråling ved åbning når sikkerhedsafbrydere er ude af funktion. Undgå udsættelse for stråling.

## 2.1 ESD PROTECTION

- レンズには絶対に触れないでください。
- DO NOT TOUCH THE LENS.
- LINSE NICHT BRÜHREN.
- NE PAS TOUCHER LA LENTILLE.

When the power supply is being turned on, you may not remove this laser cautions label. If it removes, radiation of laser may be received.

### PREPARATION OF SERVICING

Pickup Head consists of a laser diode that is very susceptible to external static electrocity.

Although it operates properly after replacement, if it was subject to electrostatic discharge during replacement, its life might be shortened. When replacing, use a conductive mat, soldering iron with ground wire, etc. to protect the laser diode form damage by static electricity.

And also, the LSI and IC are same as above.

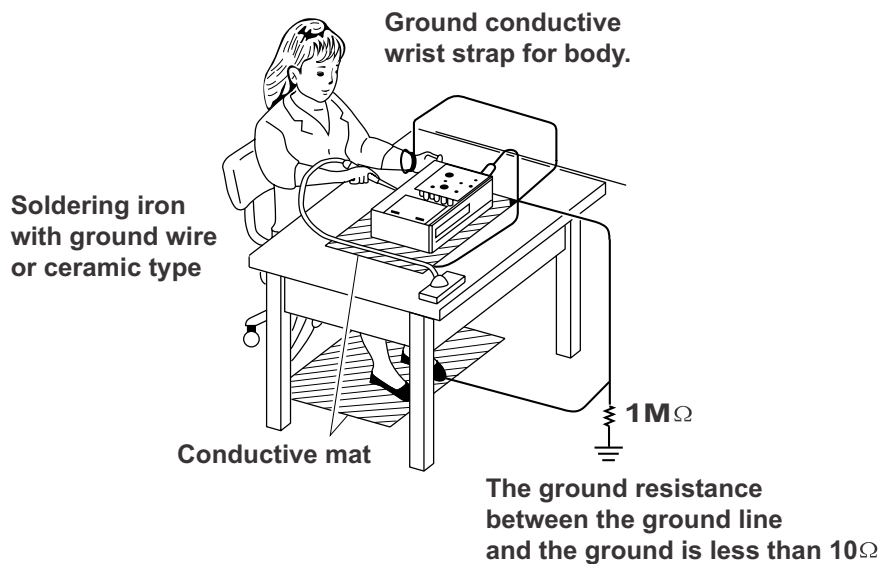

## SAFTY NOTICE

### SAFTY PRECAUTIONS

#### LEAKAGE CURRENT CHECK

Plug the AC line cord directly into a 120V AC outlet (do not use an isolation transformer for this check). Use an AC voltmeter, having  $5000\Omega$  per volt or more sensitivity. Connect a  $1500\Omega$  10W resistor, paralleled by a  $0.15\mu\text{F}$  150V AC capacitor between a known good earth ground (water pipe, conduit, etc.) and all exposed metal parts of cabinet (antennas, handle bracket, metal cabinet screwheads, metal overlays, control shafts, etc.).

Measure the AC voltage across the  $1500\Omega$  resistor. The test must be conducted with the AC switch on and then repeated with the AC switch off. The AC voltage indicated by the meter may not exceed 0.3V. A reading exceeding 0.3V indicates that a dangerous potential exists, the fault must be located and corrected. Repeat the above test with the DVD VIDEO PLAYER power plug reversed. NEVER RETURN A DVD VIDEO PLAYER TO THE CUSTOMER WITHOUT TAKING NECESSARY CORRECTIVE ACTION.

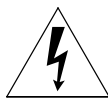
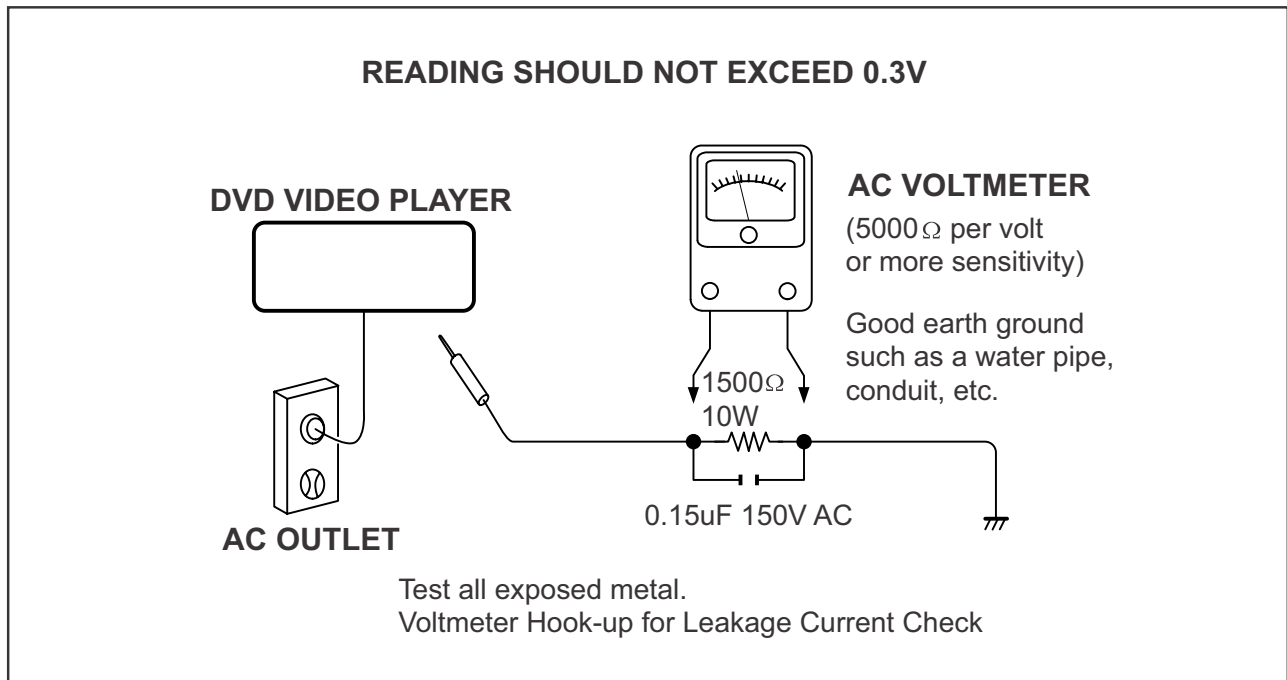

The lightning flash with arrowhead symbol, within an equilateral triangle, is intended to alert the user to the presence of uninsulated "dangerous voltage" within the product's enclosure that may be of sufficient magnitude to constitute a risk of electric shock to persons.



The exclamation point within an equilateral triangle is intended to alert the user to the presence of important operating and maintenance (servicing) instructions in the literature accompanying the appliance.

## 2.2 SAFETY INSTRUCTIONS

---

### Battery Handling Guideline

Since the battery is packed in soft package, to ensure its better performance, it's very important to carefully handle the battery

#### 2.2.1 Soft Aluminium foil

The soft aluminum packing foil is very easily damaged by sharp edge parts such as Ni-tabs, pins and needles.

- Don't strike battery with any sharp edge parts
- Trim your nail or wear glove before taking battery
- Clean worktable to make sure no any sharp particle



#### 2.2.2 Sealed edge

Sealing edge is very flimsy

- Don't bend or fold sealing edge



#### 2.2.3 Folding edge

The folding edge is form in battery process and passed all hermetic test.

- Don't open or deform folding edge



#### 2.2.4 Tabs

The battery tabs are not so stubborn especially for aluminum tab.

- Don't bend tab



#### 2.2.5 Mechanical shock

- Don't Fall, hit, bend battery body



#### 2.2.6 Short

Short terminals of battery is strictly prohibited, it may damage battery.



### 3.0 Instruction for Use

---





You can download this information from the following websites:

<http://www.philips.com/support>

<http://www.p4c.philips.com>

## 4.0 MECHANICAL AND DISMANTLING INSTRUCTIONS

---

1		Remove screws on back cabinet to separate top cabinet and back cabinet.
2		Generally open the middle cabinet.
3		Remove screws on main board. Disassemble hous and connector.
4		Remove screws on KEY board. Disassemble hous and connector.
5		Remove screws on front cabinet. Open the top cabinet

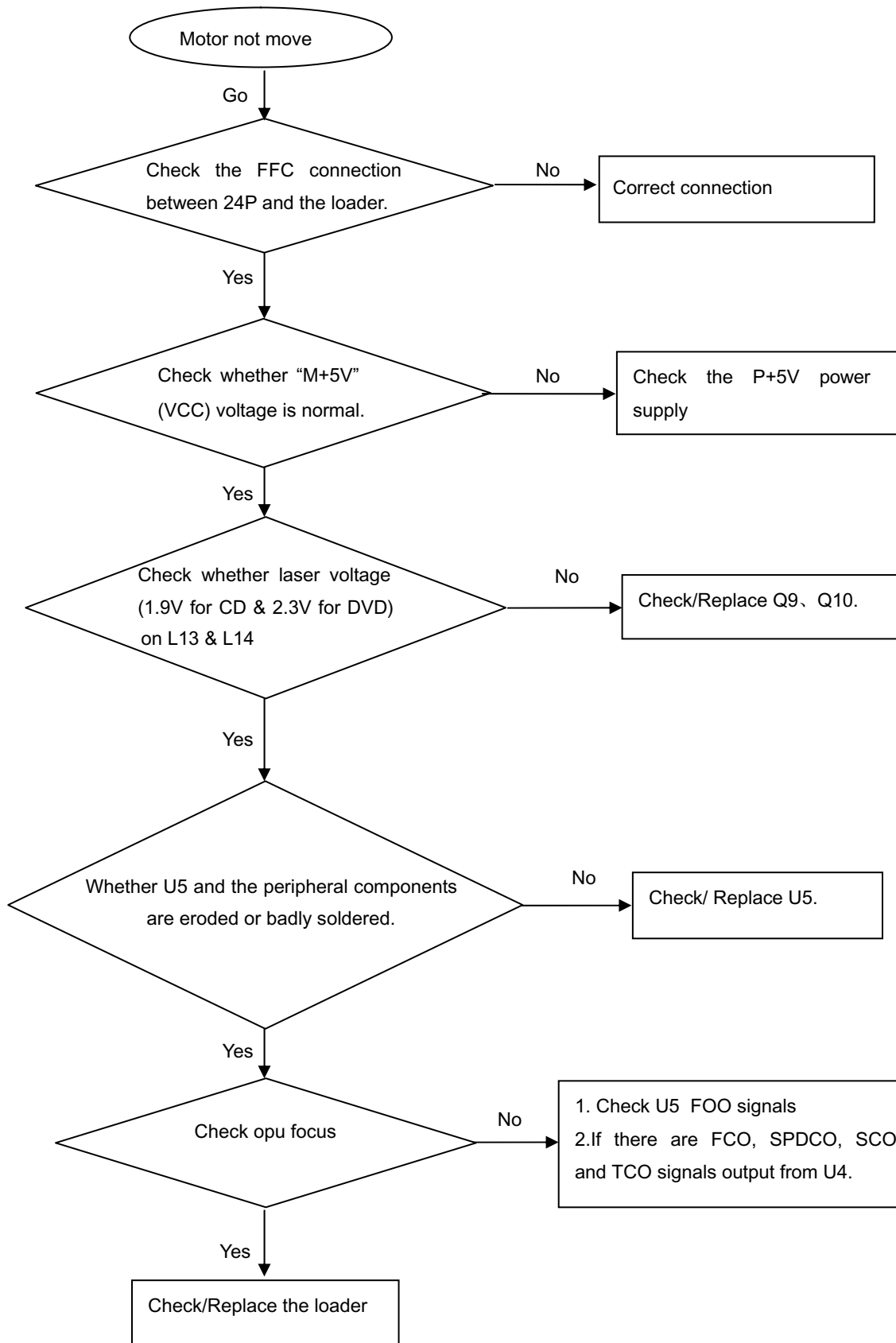
**Spindle motor does not move**

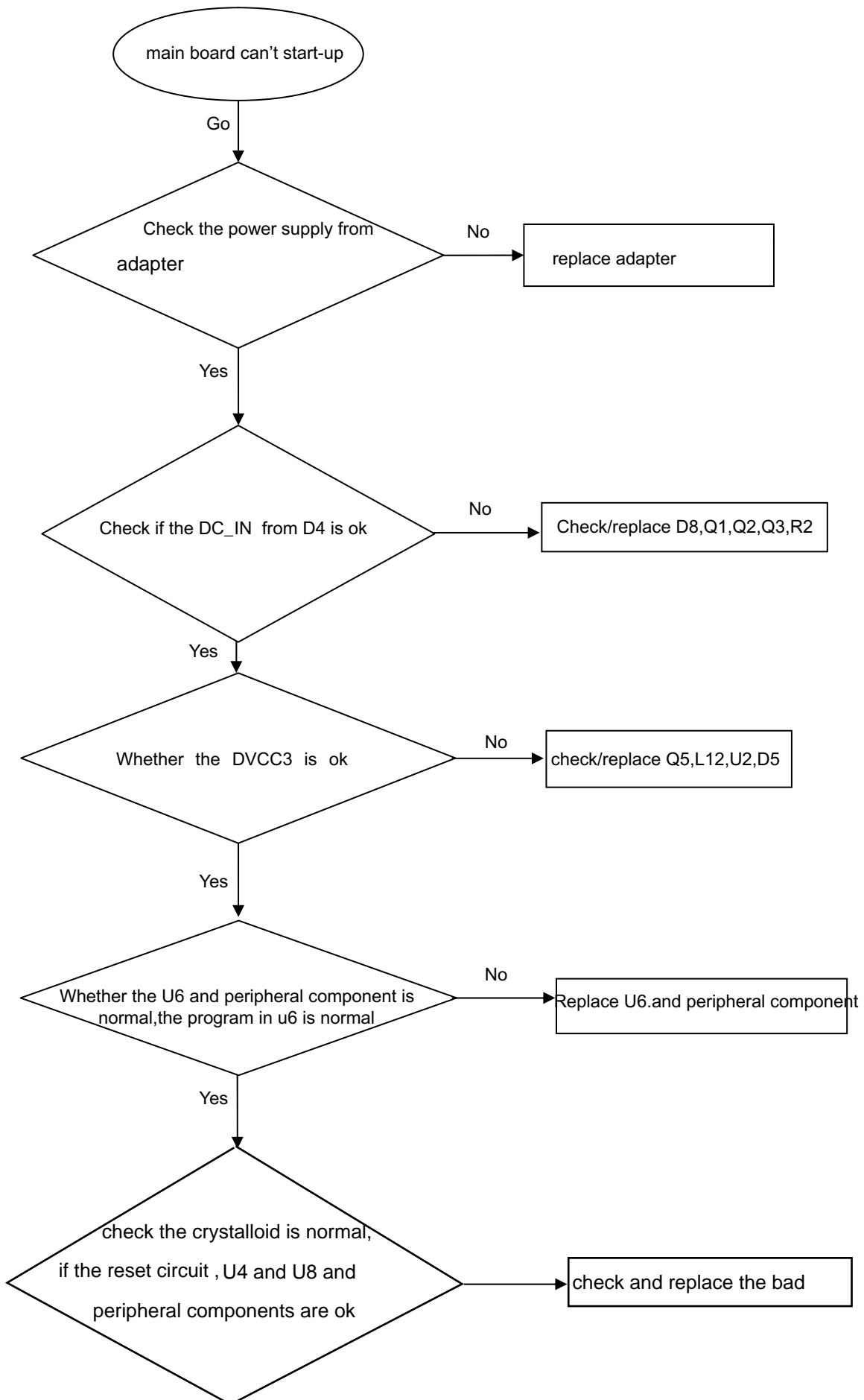
**The power can not be on or off**

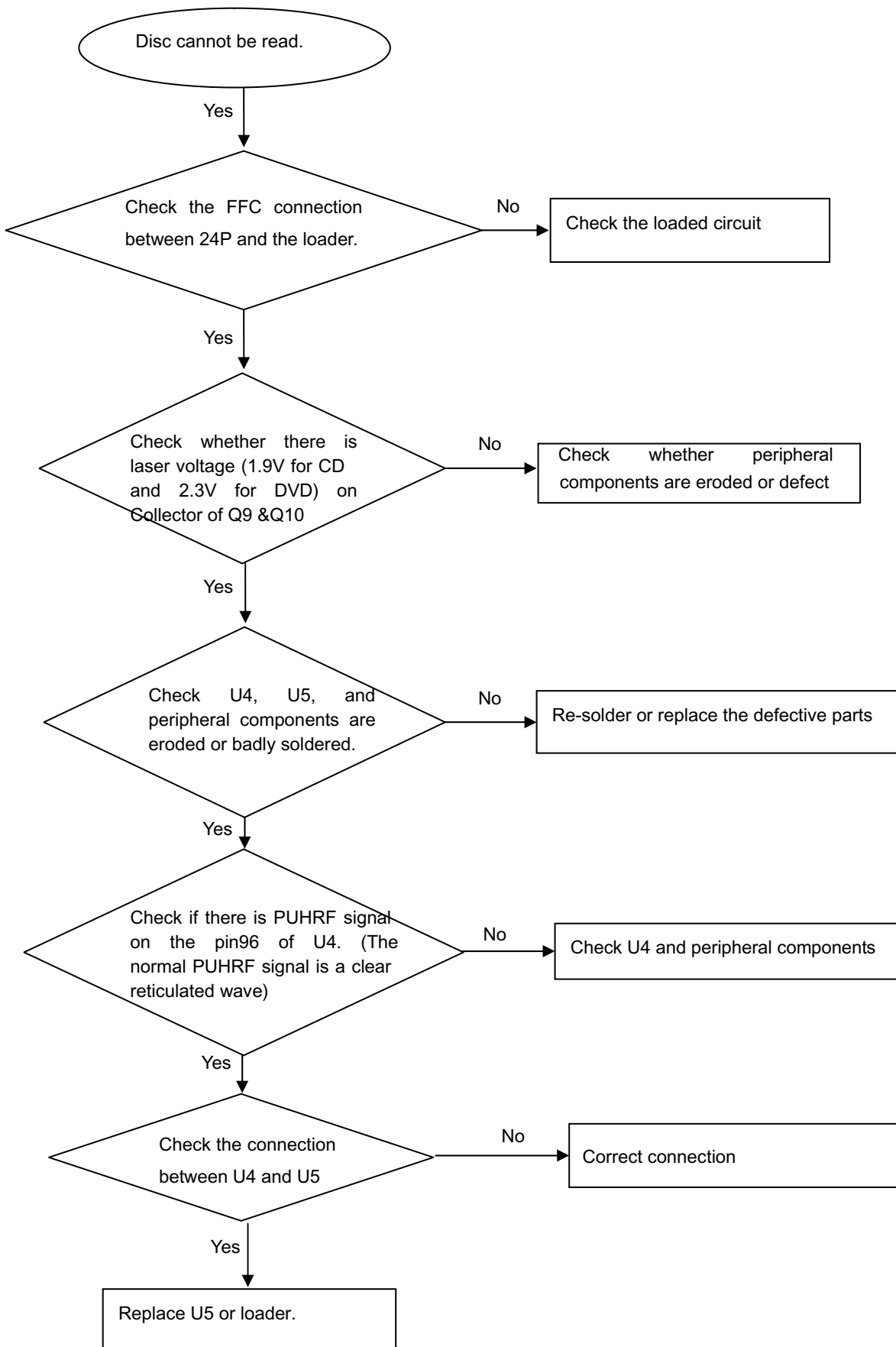
**Disc cannot be read.**

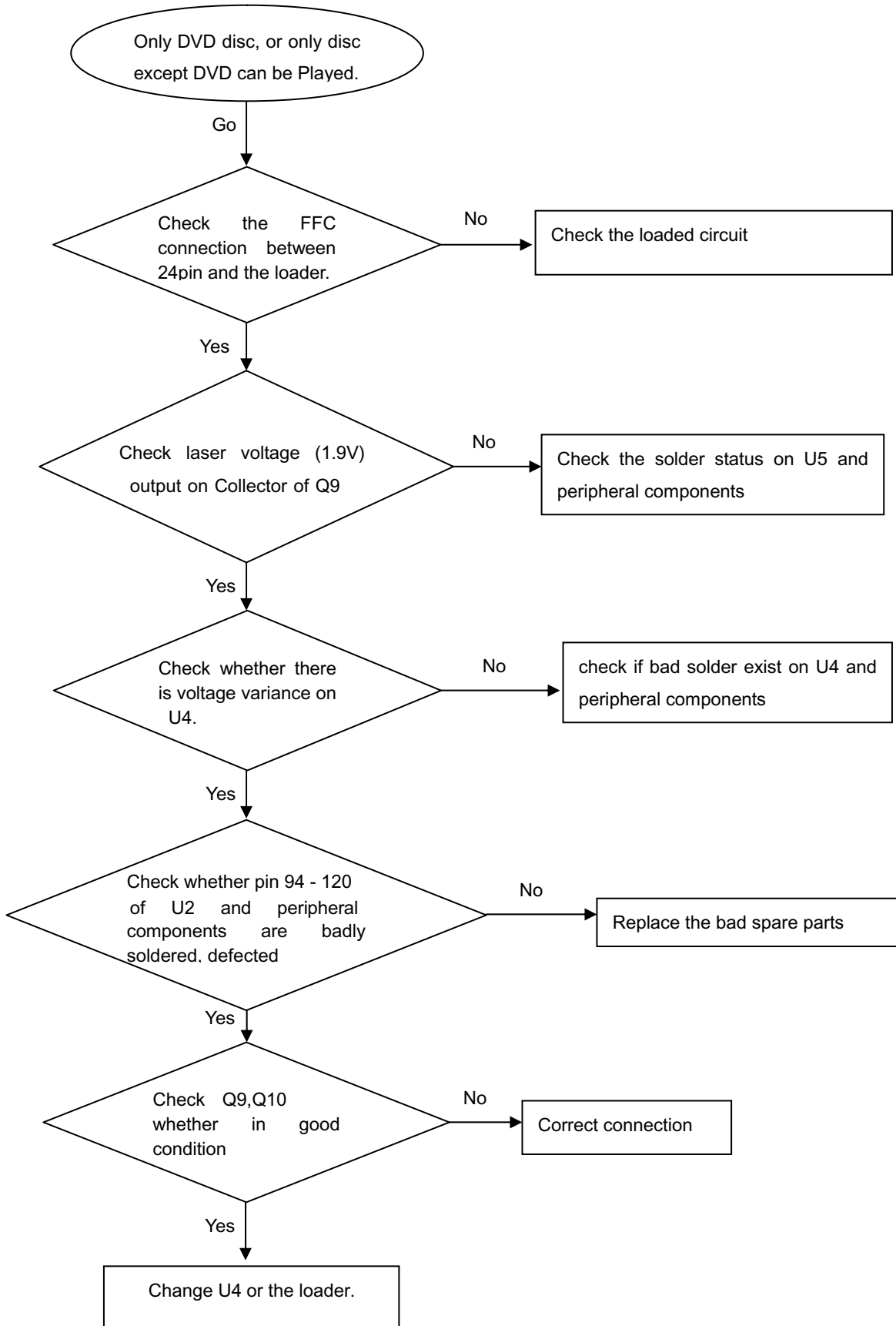
**Only DVD disc or only disc except DVD can be played**

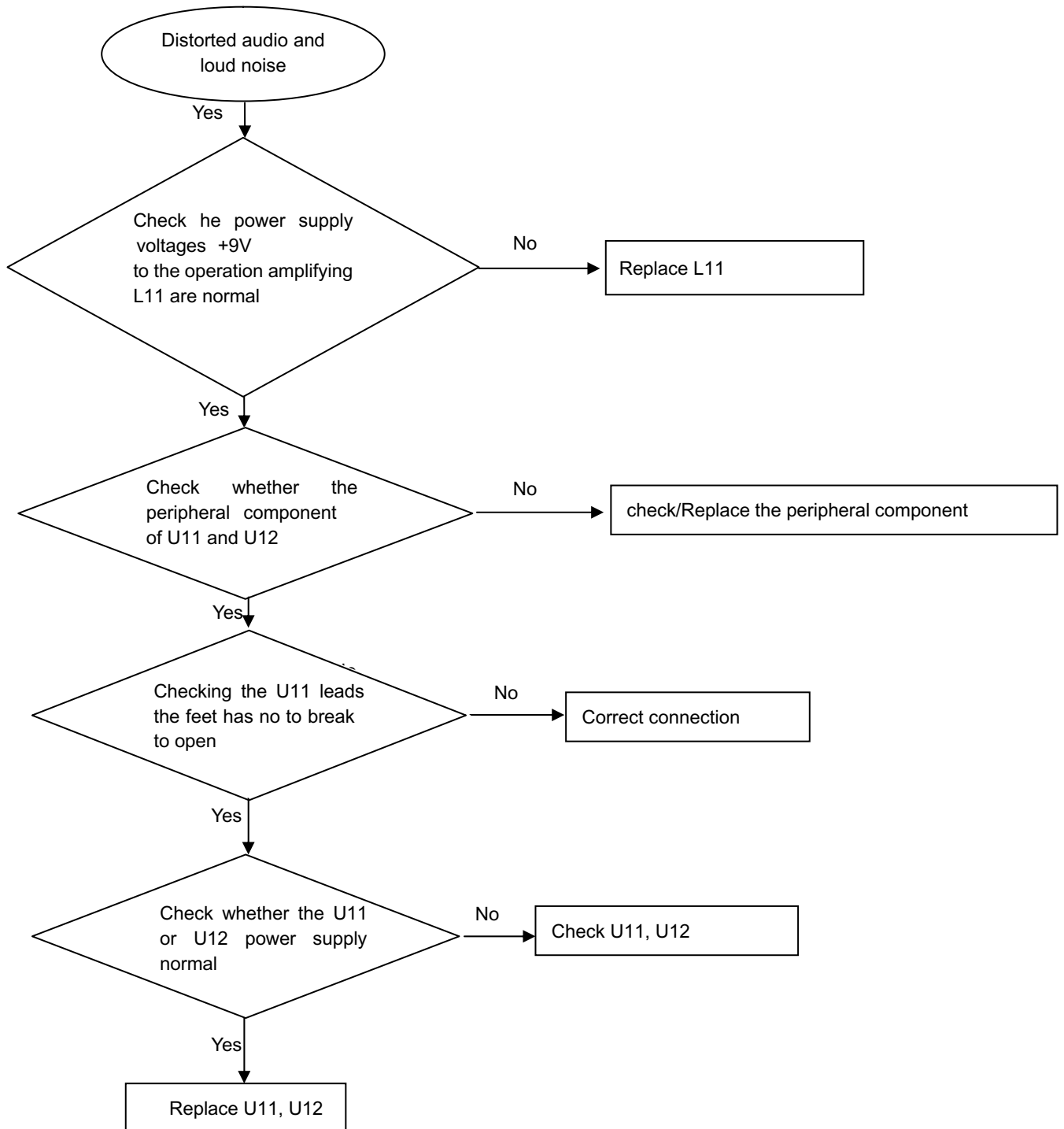
**Distorted audio and loud noise**

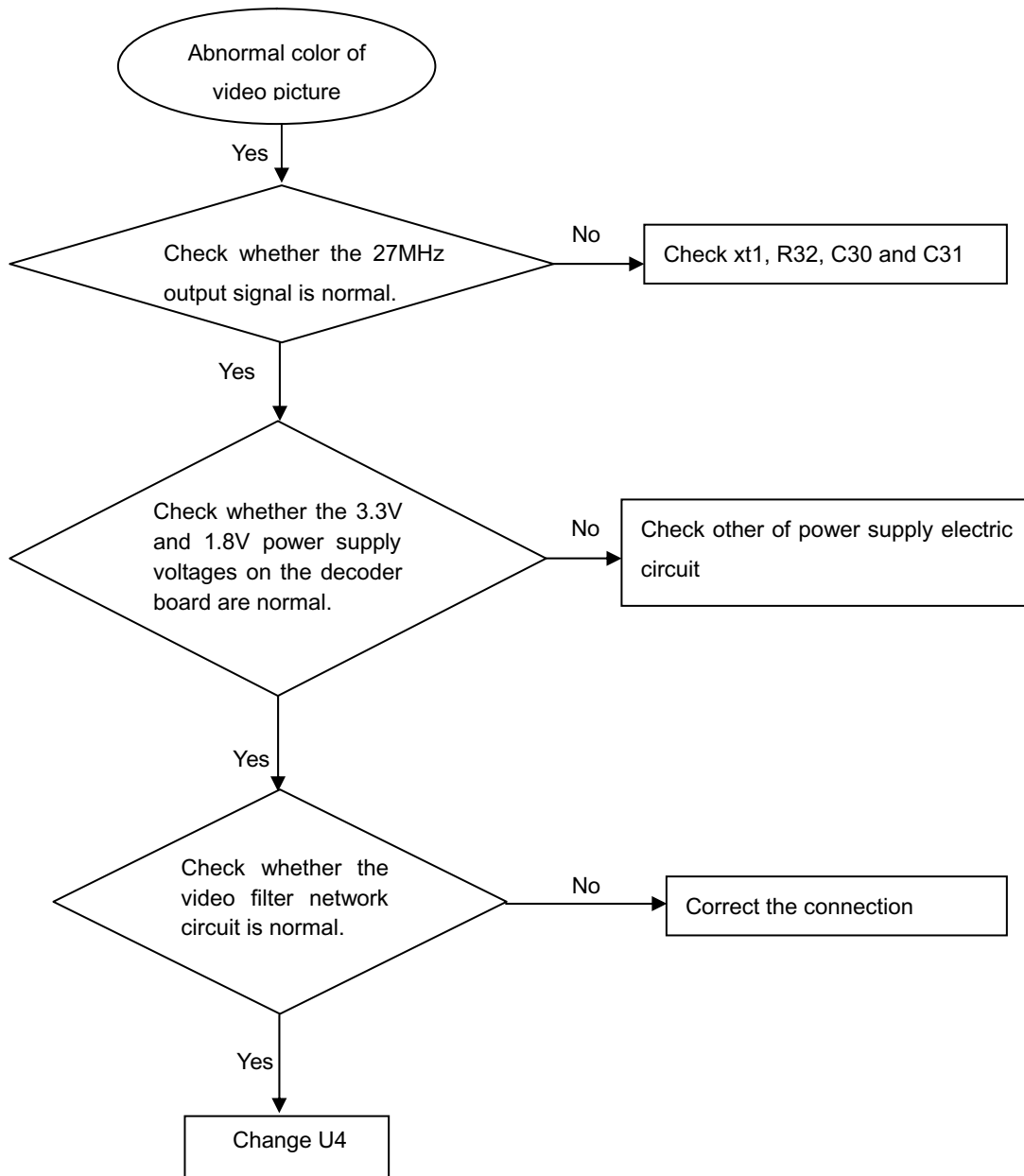
**Abnormal color of video picture**



**No video picture, no sound.**

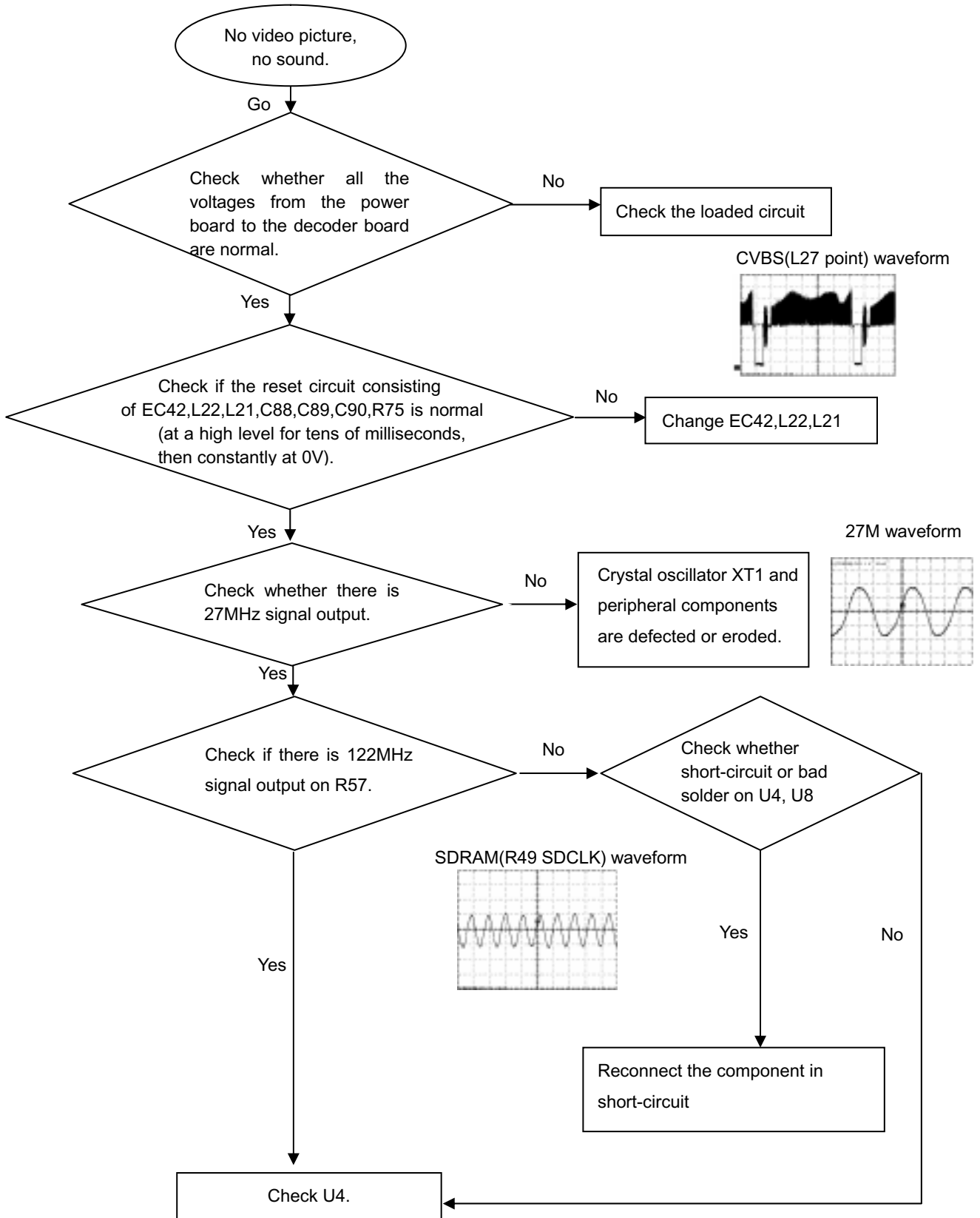

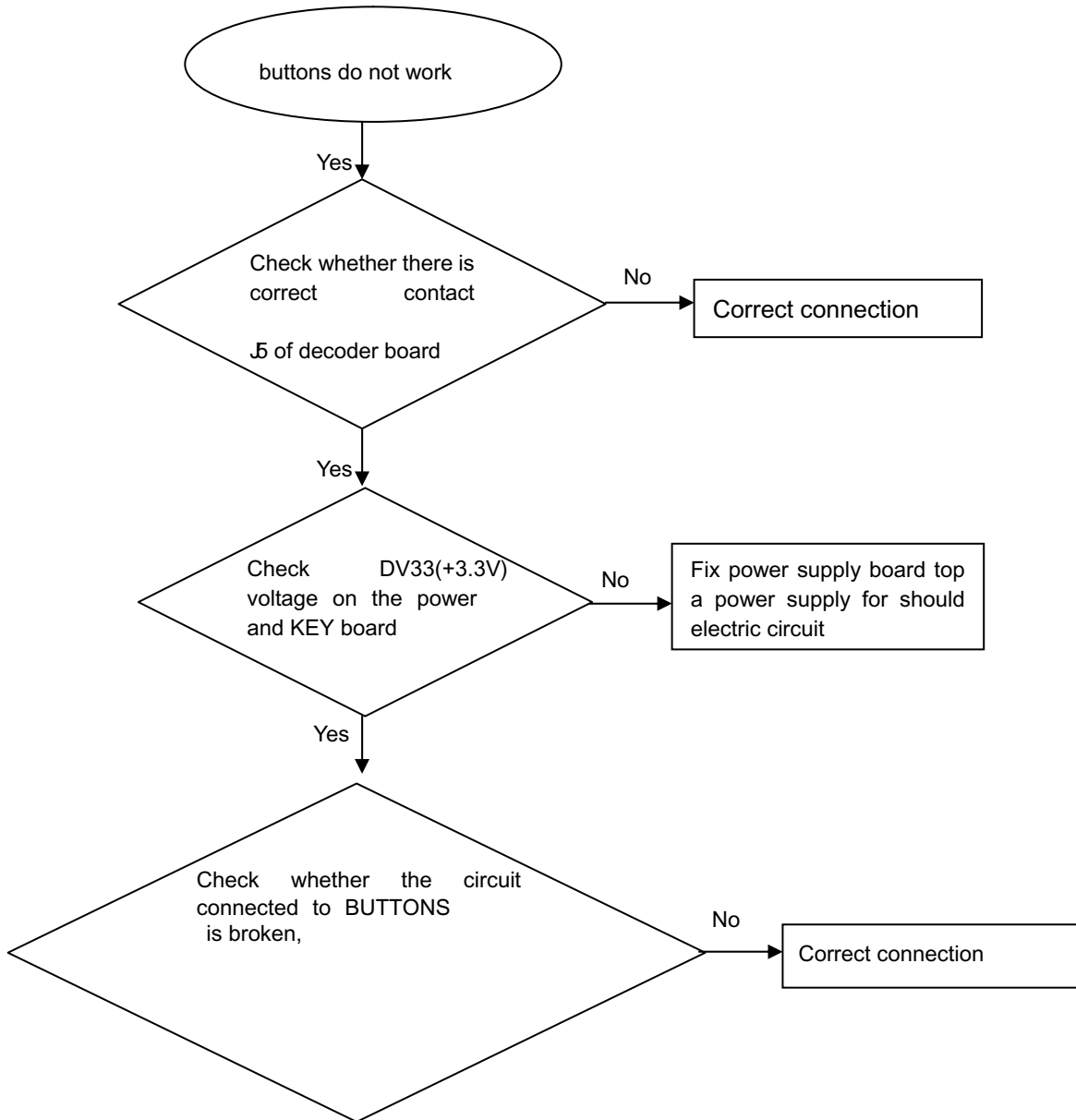
**No display on LED, and buttons do not work**

OVERALL BLOCK DIAGRAM

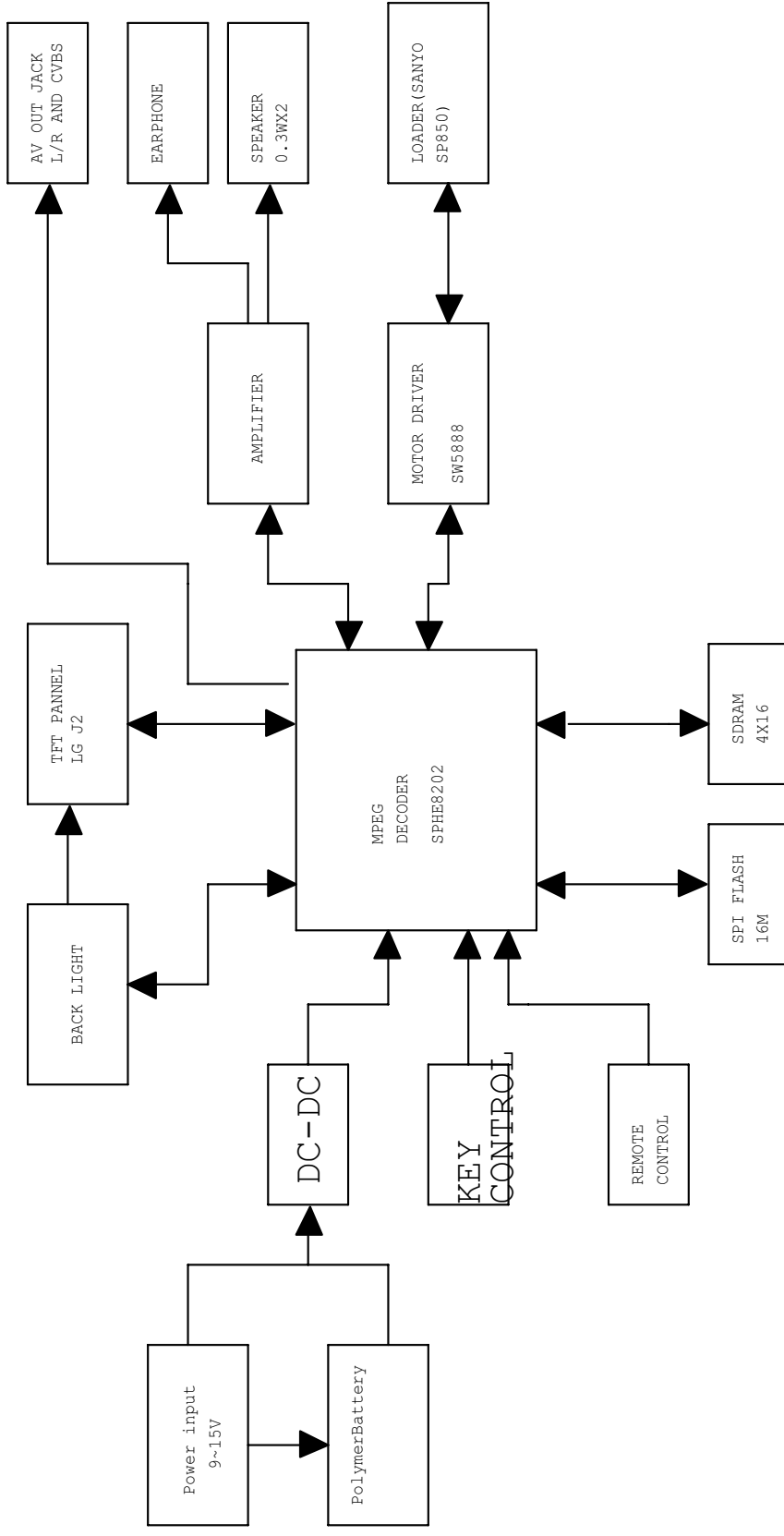







CIRCUIT DIAGRAM-DVD MAIN BOARD

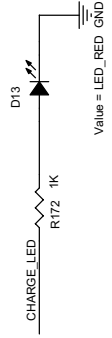
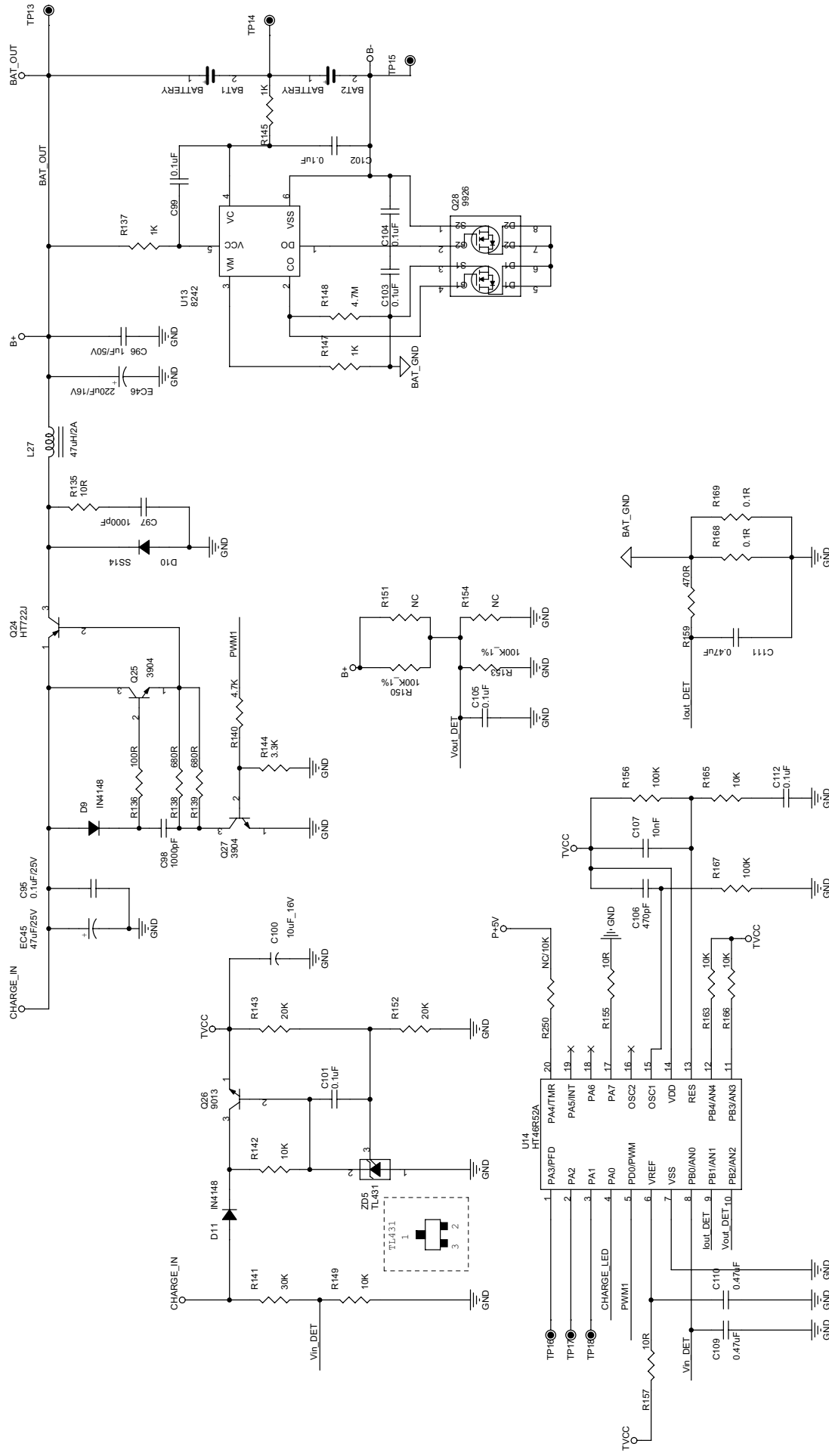

# CIRCUIT DIAGRAM-DVD MAIN BOARD

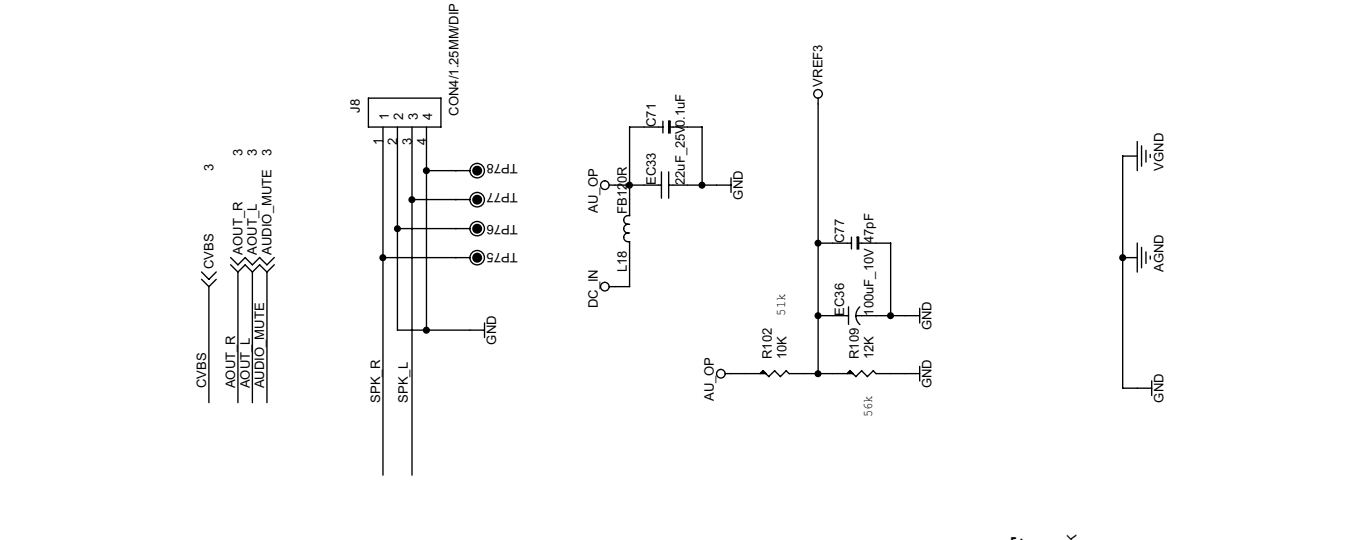
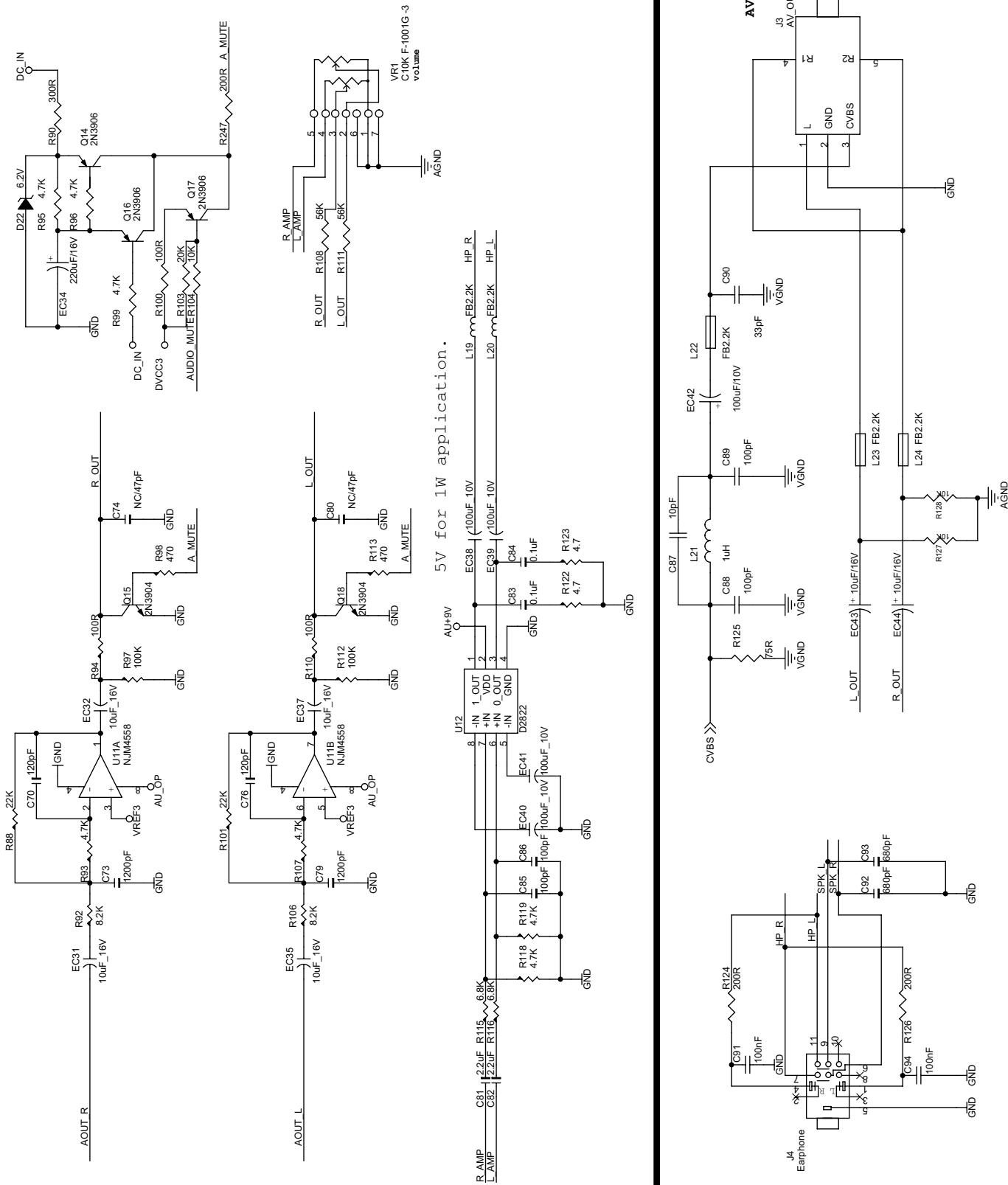





CIRCUIT DIAGRAM- KEY BOARD

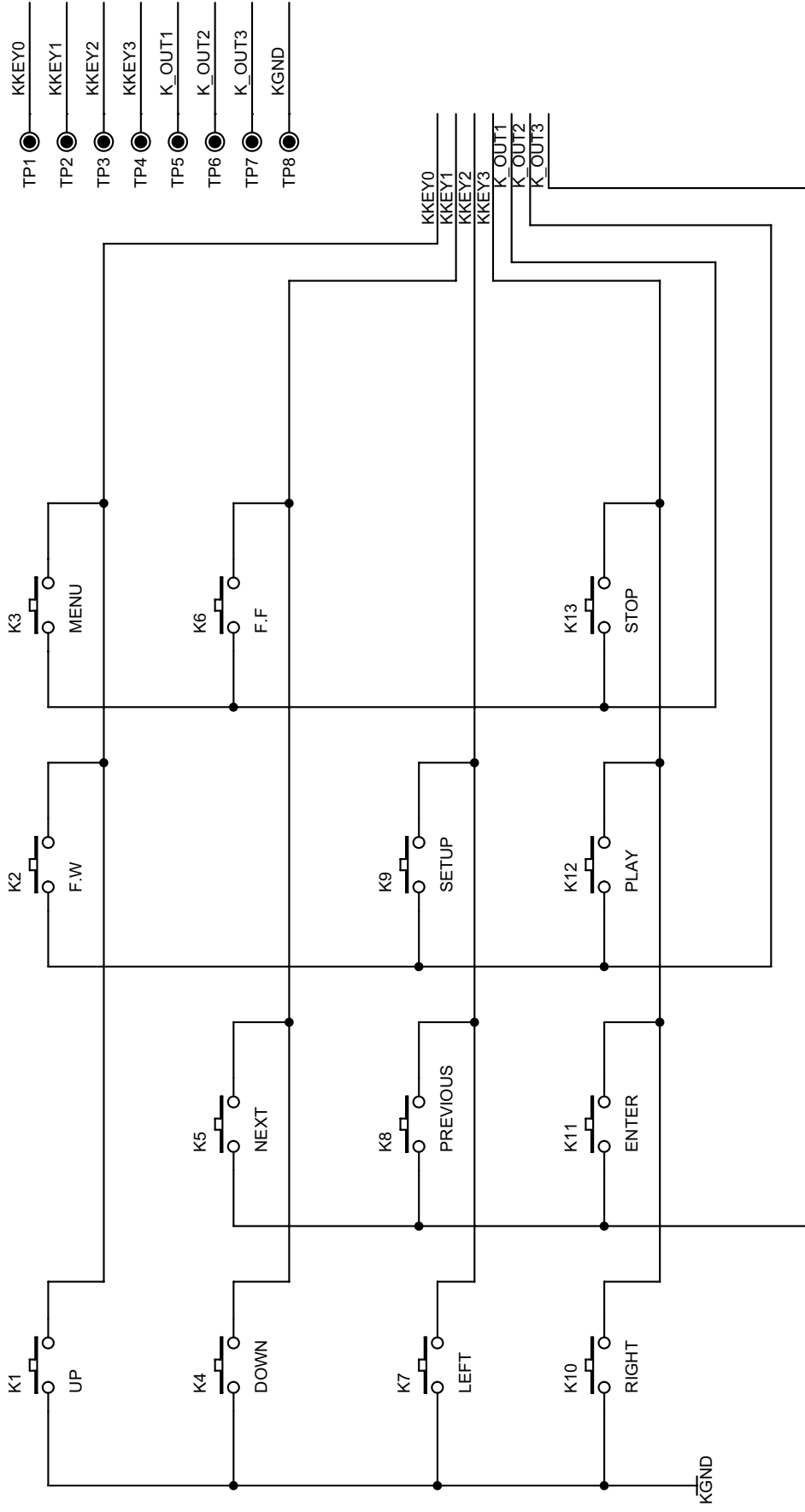



MAIN BOARD-BOTTOM

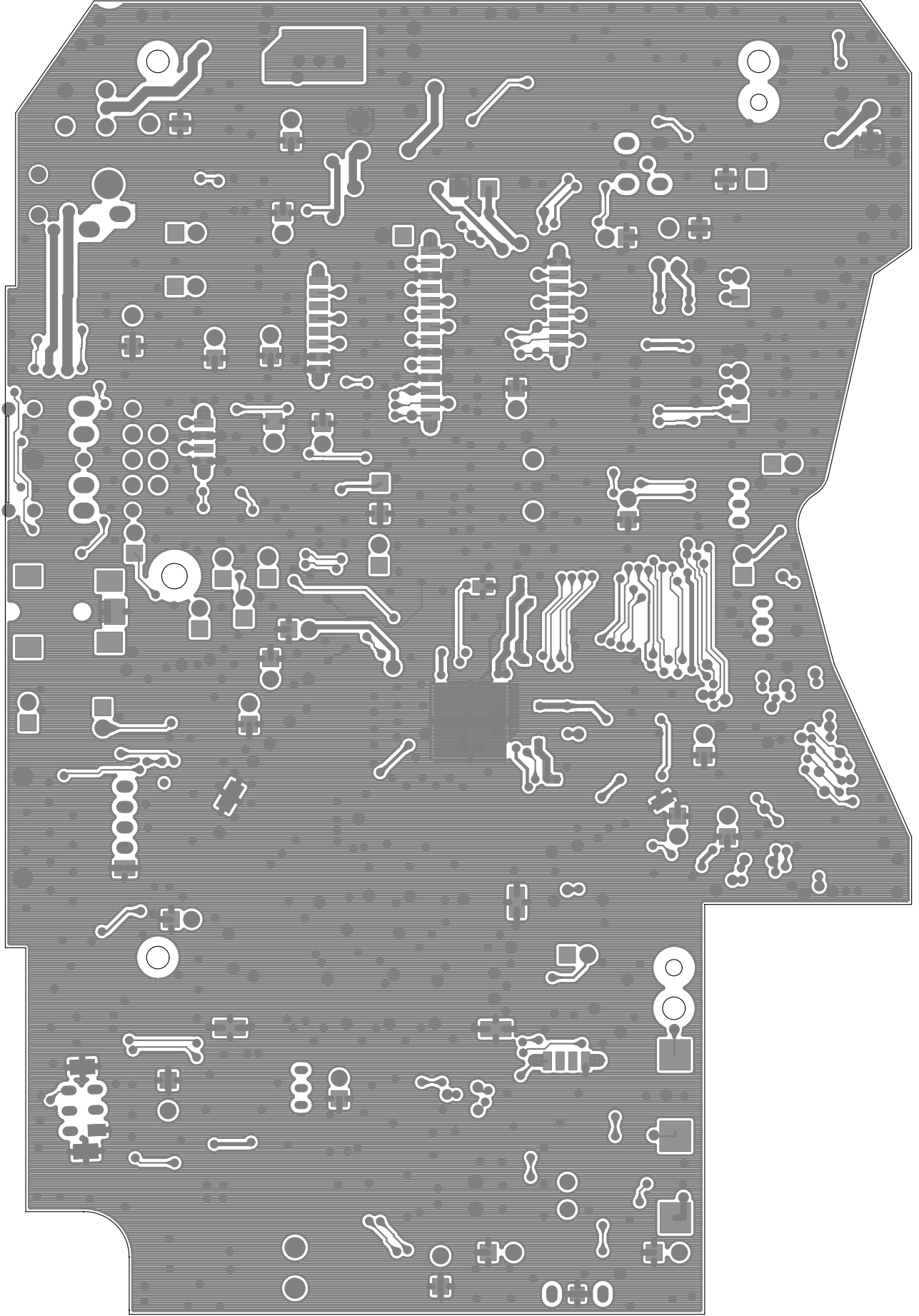

# TFT BOARD-TOP

7-10

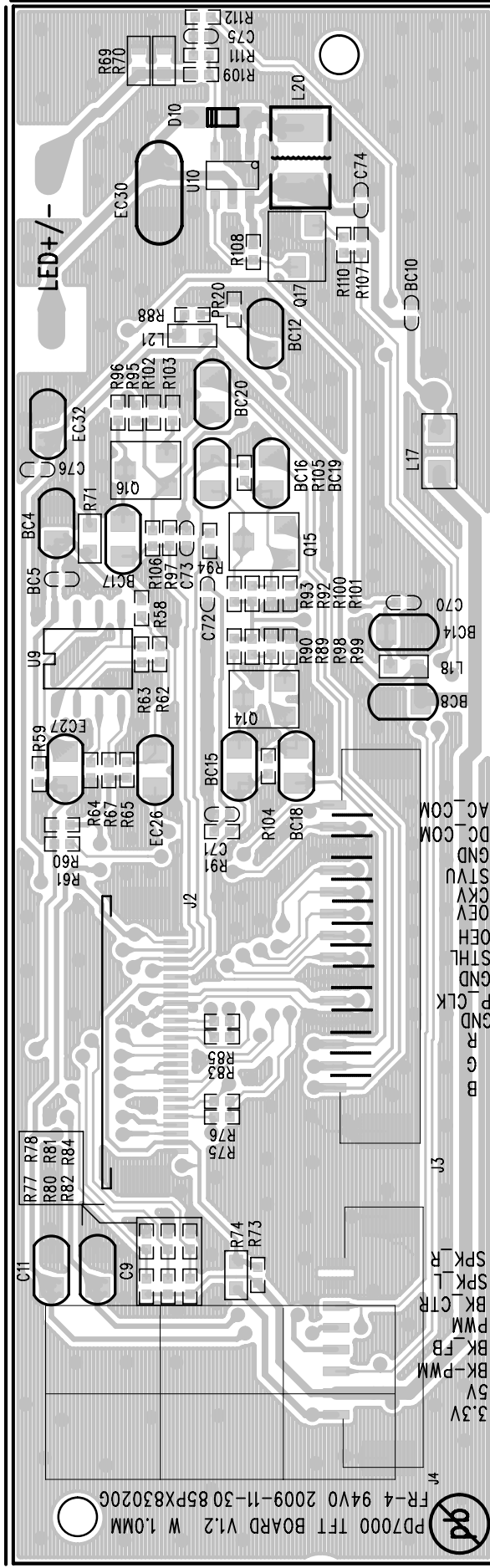

TFT BOARD-BOTTOM

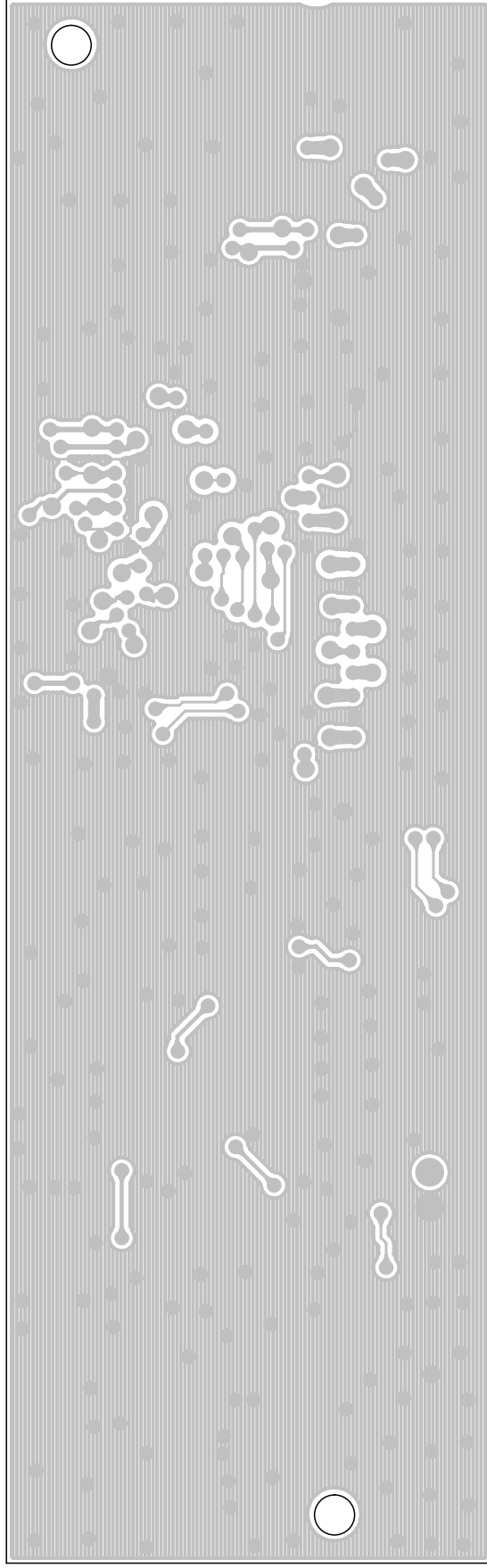

KEY BOARD-TOP

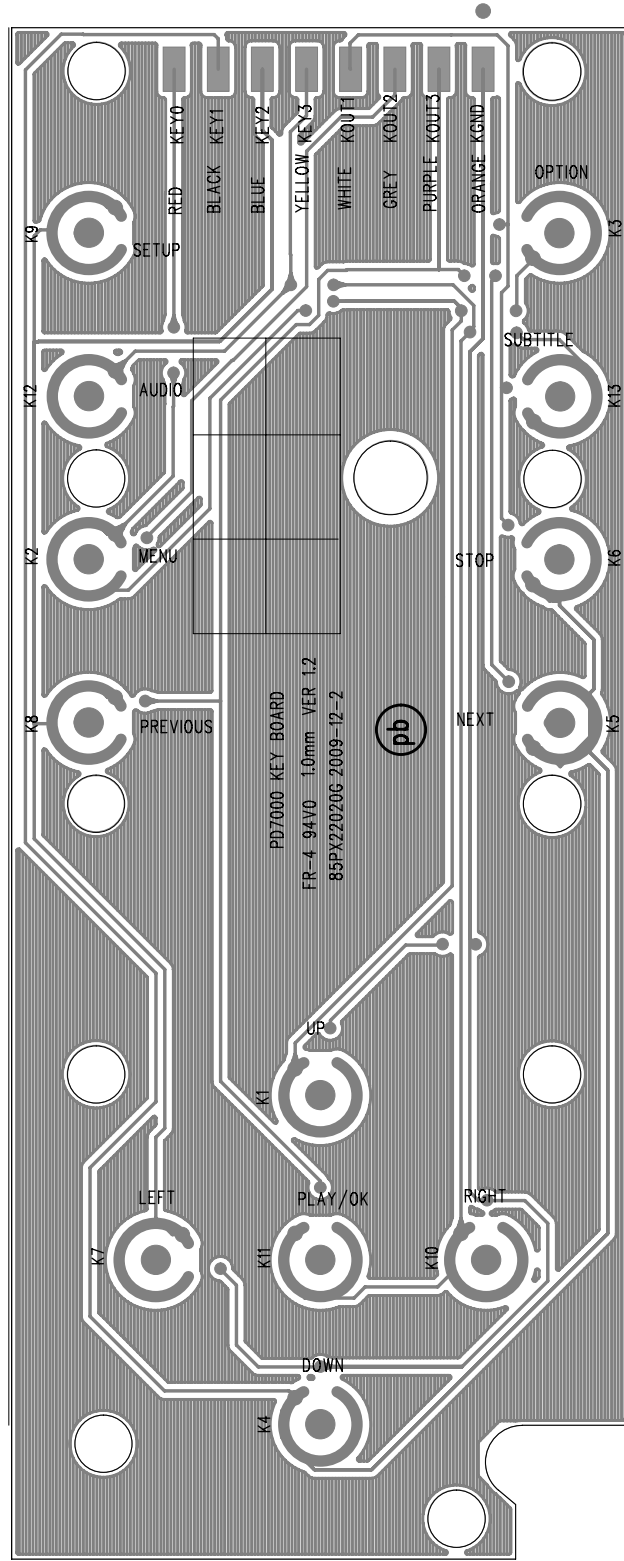

KEY BOARD-BOTTOM

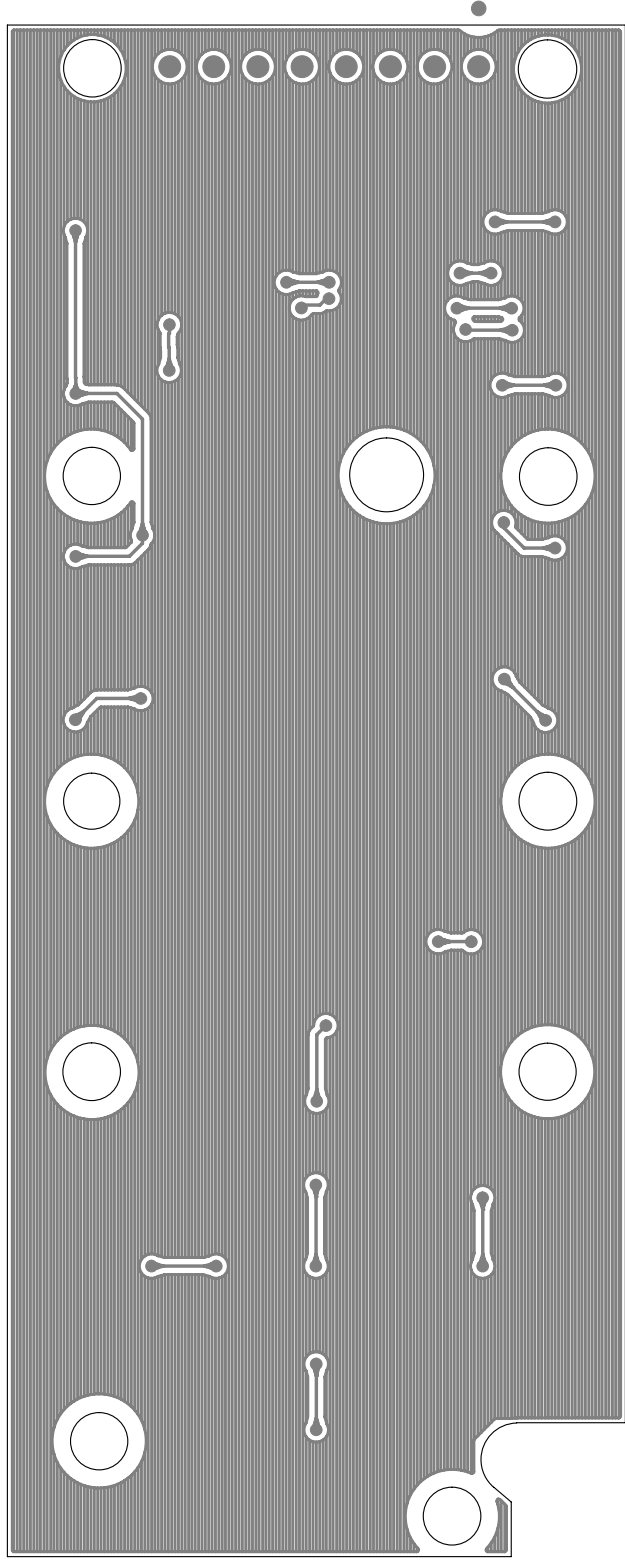



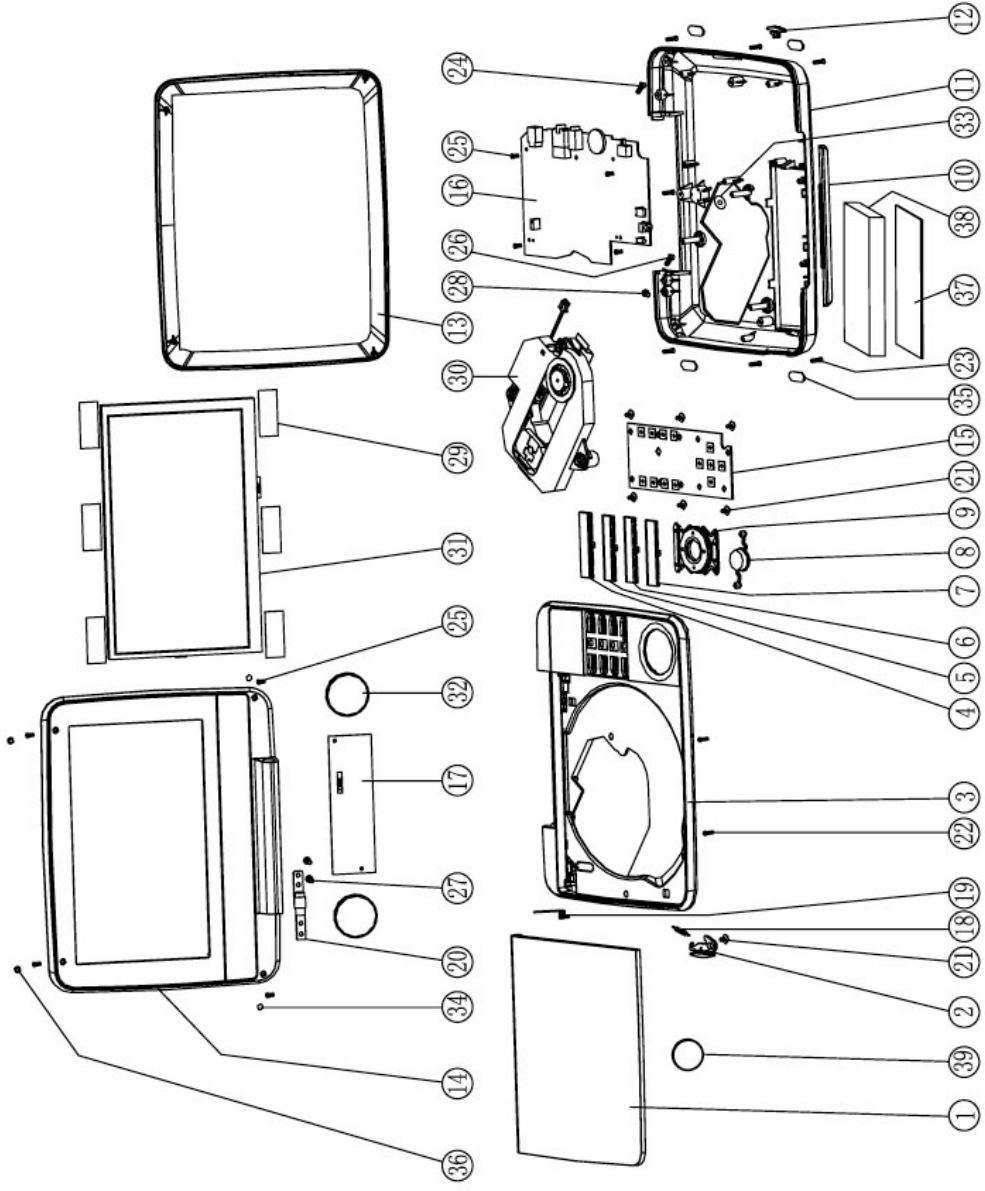











## 81 SERVICE PART LIST

CTN	Service 12NC	Service Description	Photo	Pos. No.
PD7010/12	996510032058	DVD DOOR PC BLACK		1
PD7010/12	996510021997	LENS ABS PET741D		10
PD7010/12	996510032067	BOTTOM-HOUSING WHITE		11
PD7010/12	996510032069	POWER KNOB ABS WHITE		12
PD7010/12	996510032066	TOP-FRAME ABS WHITE		13
PD7010/12	996510032057	DISPLAY-FRAME ABS		14
PD7010/12	996510031372	KEY PCBA ASSY PD7000		15
PD7010/12	996510032091	MAIN PCBA ASSY		16
PD7010/12	996510031375	TFT PCBA ASSY PD7000		17
PD7010/12	996510032068	OPEN KEY ABS WHITE		2
PD7010/12	996510032059	DVD MIDDLE-FRAME ABS		3
PD7010/12	996510028871	DVD DECK PM2381D(SFHD850PH-S)		30
PD7010/12	996510032098	PANEL FINAL ASSY		31
PD7010/12	996510032056	BAT LI-ION 7.4V YOKU		38

## 81 SERVICE PART LIST

CTN	Service 12NC	Service Description	Photo	Pos. No.
PD7010/12	996510032061	PLAY KEY1 ABS BLACK		4
PD7010/12	996510032062	PLAY KEY2 ABS BLACK		5
PD7010/12	996510032063	PLAY KEY3 ABS		6
PD7010/12	996510032064	PLAY KEY4 ABS		7
PD7010/12	996510032065	KEY-OK ABS		8
PD7010/12	996510031334	KEY-SELECT ABS PET741B		9
PD7010/12	996510031235	SW ADP 9V/0.8A VDE 4.0 BLACK		ADAPTOR
PD7010/12	996510021031	CAR CORD PET741		CARADAPTOR
PD7010/12	996510032055	GAME CD-R DISC		GAMEDISC
PD7010/12	996510032078	GAME HANDGRIP ASSY		GAMEPAD
PD7010/12	996510031499	TRAVEL BAG FOR PHILIPS		MOUNTINGBAG

## 9.0 REVISION LIST

---

Version 1.0

- Initial release

Version 2.0

- Add version /93/77